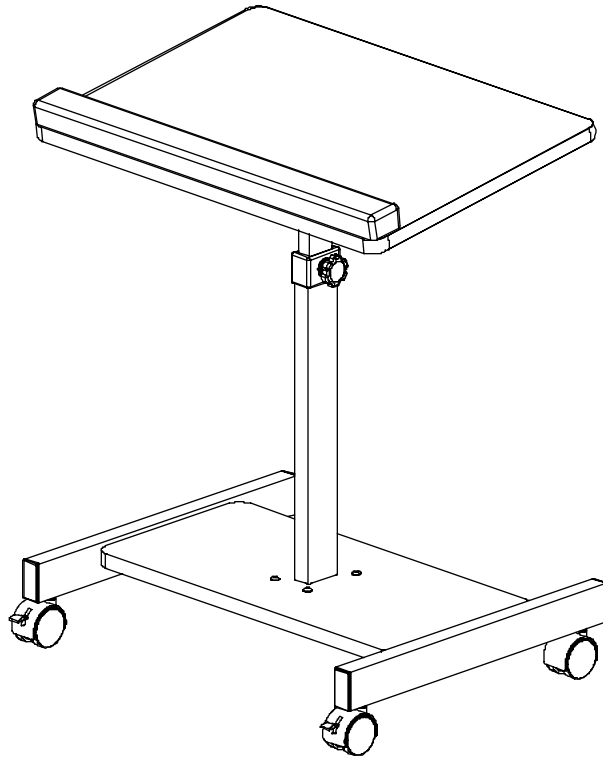


**BALT**<sup>®</sup>

# SCAMP-1

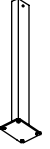













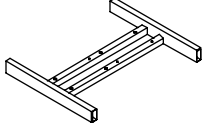
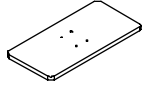
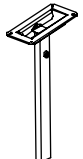
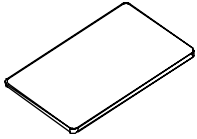


Mobile Tilting Keyboard Stand



## Assembly Instructions

# Scamp-1

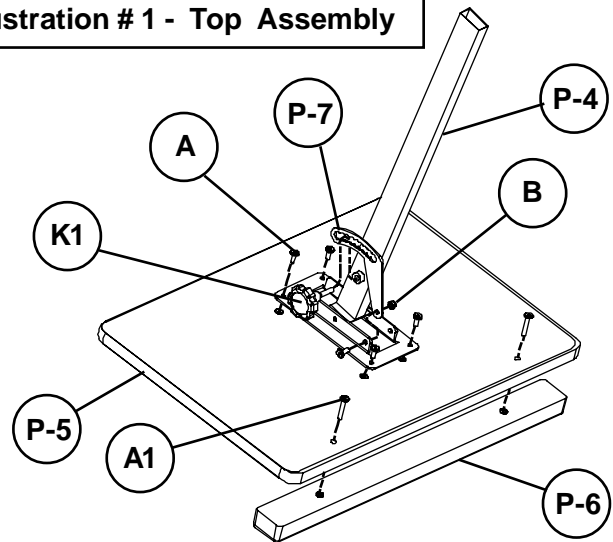
# Mobile Tilting Keyboard Stand

Part	Drawing	Description	Qty	Part	Drawing	Description	Qty
P-1		Lower Receiver	1 EA	<b>Hardware List</b> A  Flat Head Screw 6 EA A1  1 1/4" Long Flat Head Screw 2 EA A2  1 1/2" Long Flat Head Screw 8 EA B  Lock Nut 1 EA C  Interior Threaded Post 4 EA D  2" Locking Caster (for Front) 2 EA E  2" Caster (for Back) 2 EA F  Allen Wrench 1 EA G  Caster Wrench 1 EA K1  Large Knob 1 EA K2  Small Knob 1 EA M  Plastic Cap 1 EA N  Plastic Sleeve 1 EA			
P-2		Foot Assembly	1 EA				
P-3		Bottom Shelf	1 EA				
P-4		Upper Insert	1 EA				
P-5		Top Platform	1 EA				
P-6		Wrist Rest Pad	1 EA				
P-7		Tilting Bracket	1 EA				

### To Assemble:

1. Identify and Separate all the Parts and Hardware.
2. Place the Top Platform (P-5) with the insert nuts facing up. Attach Upper Insert (P-4) using 4 Flat Head screws (A) as shown in illustration # 1.
3. Attach Tilting Bracket (P-7) to the Upper Insert (P-4) using 1 Flat Head screw (A) and 1 Lock Nut (B). Insert Large Knob (K1) through the Tilting bracket to the Threaded hole on the tube.
4. Attach Wrist Rest Pad (P-6) to the Top Platform (P-5) using 2- 1 1/4" Long Flat Head screws (A1).

Illustration # 1 - Top Assembly

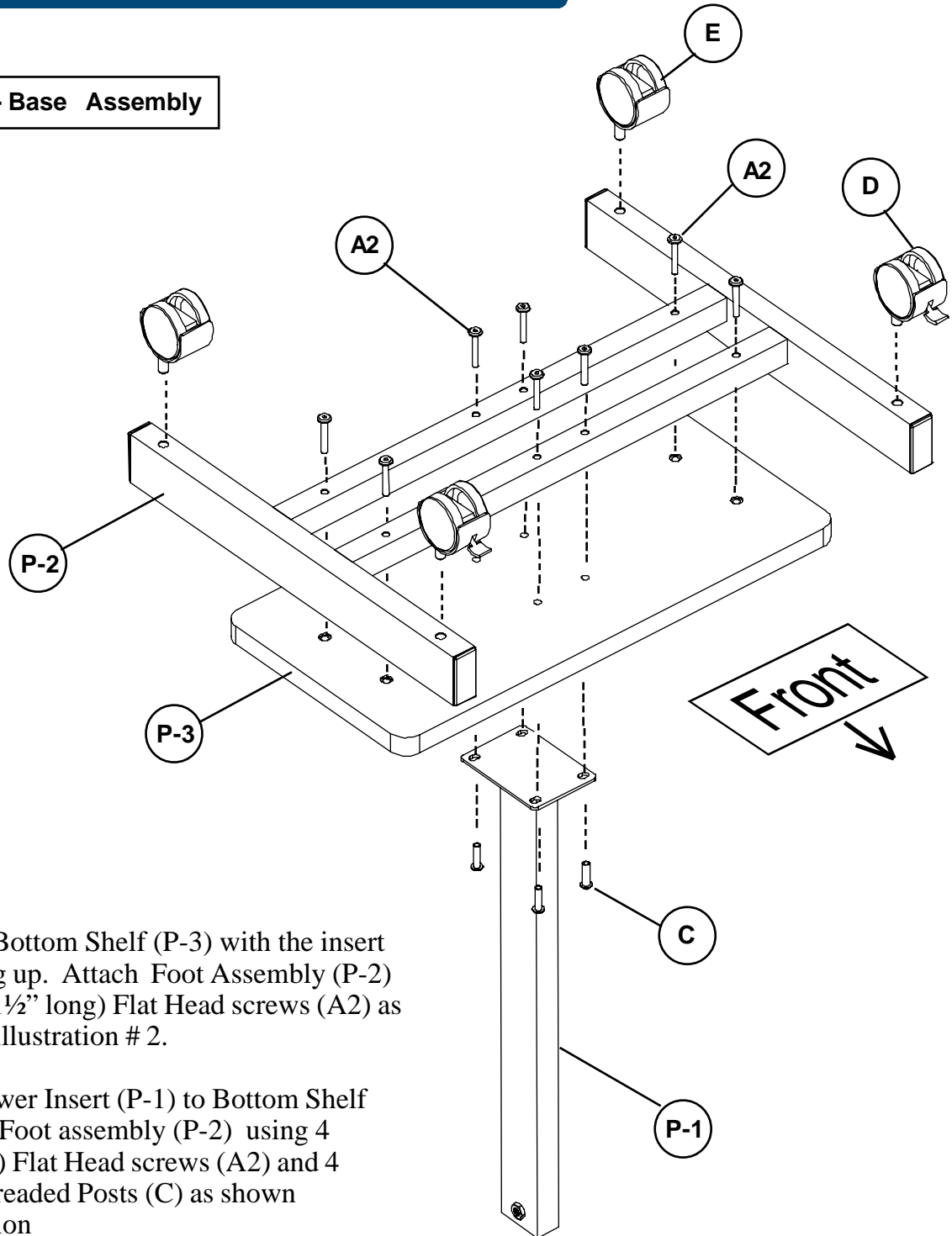


# SCAMP-1

## Assembly Diagram

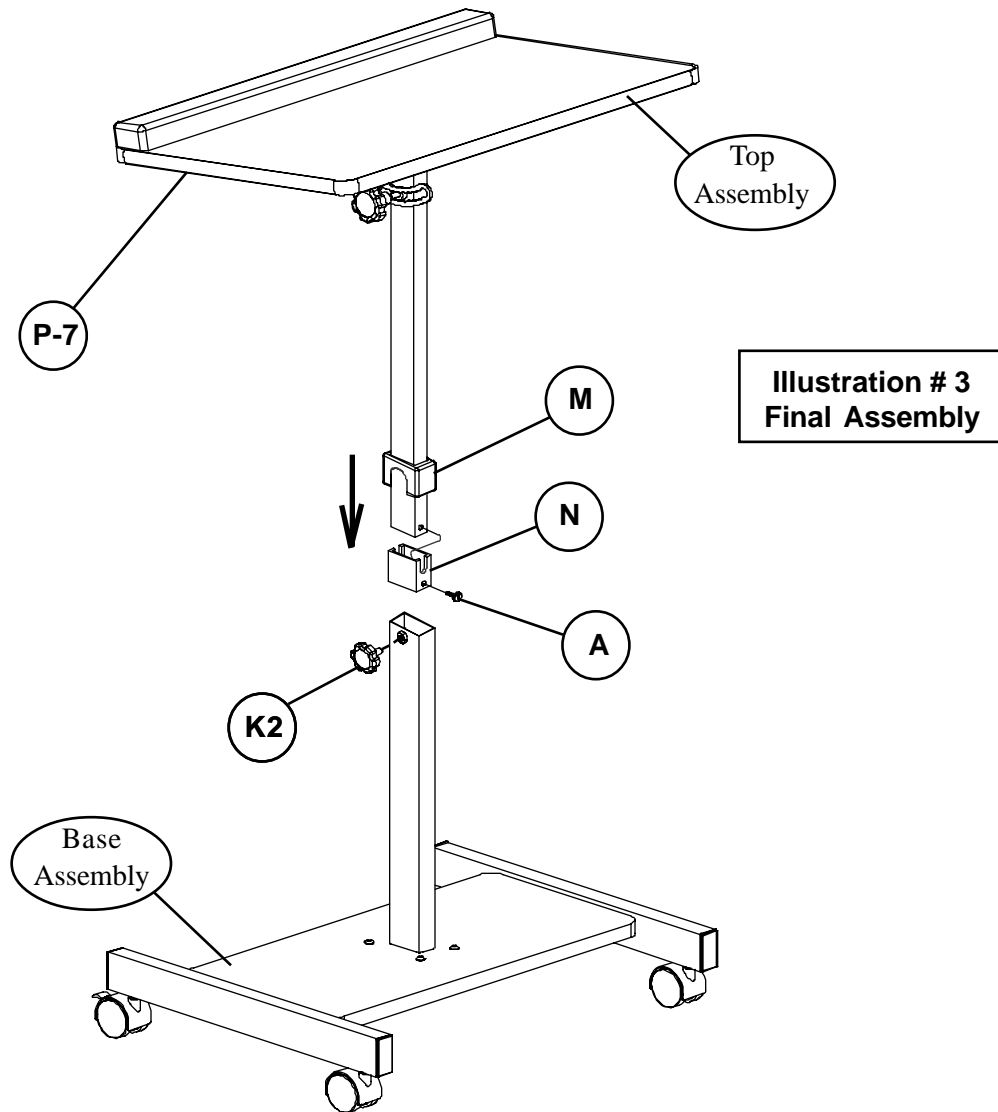


Illustration # 2 - Base Assembly



5. Place the Bottom Shelf (P-3) with the insert nuts facing up. Attach Foot Assembly (P-2) using 4- (1½" long) Flat Head screws (A2) as shown in illustration # 2.
6. Attach Lower Insert (P-1) to Bottom Shelf (P-3) and Foot assembly (P-2) using 4 (1½" long) Flat Head screws (A2) and 4 Interior threaded Posts (C) as shown in illustration
7. Attach Casters to Foot assembly (P-2) [ 2 Locking casters (D) in the front and 2 Casters (E) in the back.] Note the location of the small hole on the Lower Receiver (P-1) which determines front and back of the unit as shown in illustration #2. Tighten the Casters using Caster Wrench (G).

8. Please refer to the details on next page for assembling Plastic Cap (M), and Plastic Sleeve (N).
9. Slide the Top Assembly into the Base Assembly and Secure at desired height using Small Knob (K2).



Do not use unless all screws are tight.  
At least every six months, check all screws  
to be sure they are tight.  
If parts are missing, broken, damaged, or  
worn, stop use of the product until repairs  
are made by your dealer using factory  
authorized parts.

***Should you require assistance during assembly,  
please call our Customer Service Department  
Monday - Friday 8 a.m. - 5 p.m.  
Central Standard Time  
Toll-Free Customer Service  
1-800-749-2258***

## DETAILS OF ASSEMBLING PLASTIC CAP 'M' & SLEEVE 'N'

1. Slide Plastic Cap (M) [with Cutout on the same side as the tilting bracket on the Upper insert], then attach the Plastic sleeve (N) over the end of insert. Make sure that the hole on the Part N and the hole on the Upper insert tube line up, then attach it with a Flat Head screw (A).
2. Insert Upper insert into the Lower Receiver tube, and slide Part M down, so that it should be resting on top of the Lower Receiver Tube. Adjust to the desired height and secure with the Small Knob (G2) as shown in Illustration below.

