

BALT[®]

FREEDOM Dual Adjustment Workstation

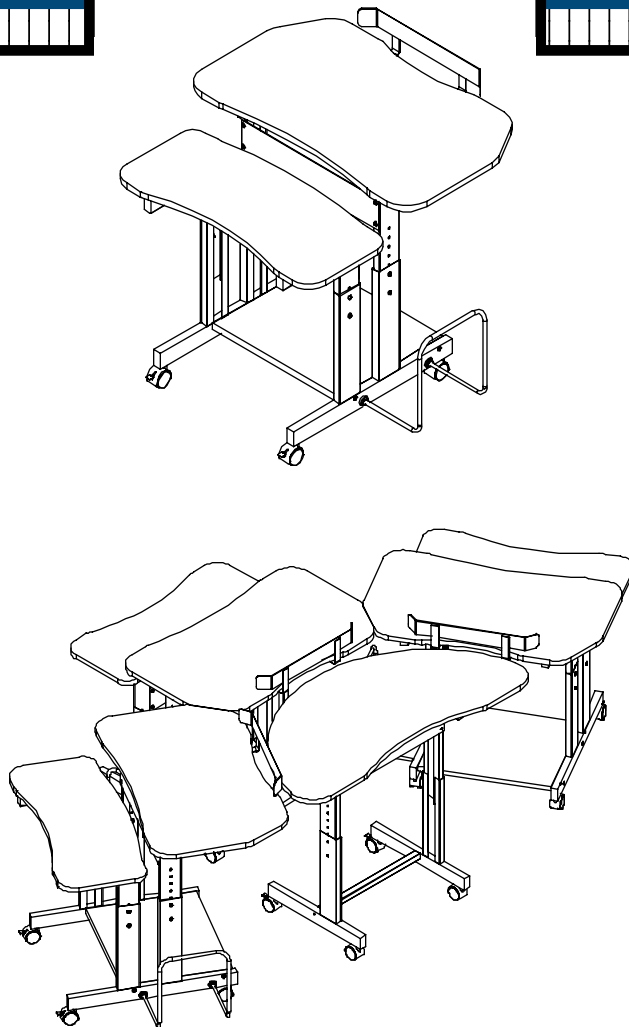











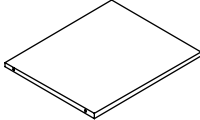
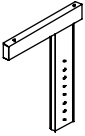
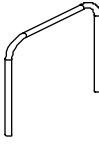
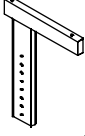

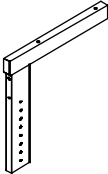
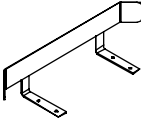
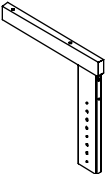

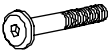







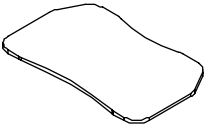
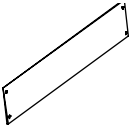
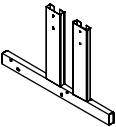
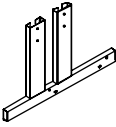

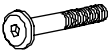





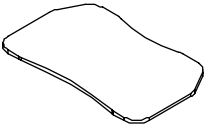
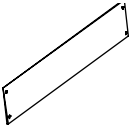
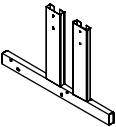
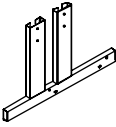

Assembly Instructions

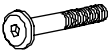
See back for important information, including our
Toll-Free Customer Service Telephone Number

FREEDOM

Dual Adjustment Workstation

Assembly Instructions

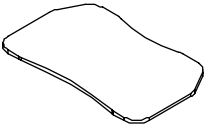
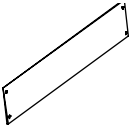
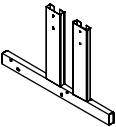
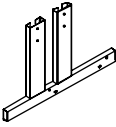
Part	Drawing	Description	Qty	Part	Drawing	Description	Qty																																																												
P-1		Small Top Platform	1 EA	P-10		Accessory Platform	1 EA																																																												
P-2		Right Small Top Support	1 EA	P-11		CPU Sleeve	1 EA																																																												
P-3		Left Small Top Support	1 EA	P-12		CPU Rod	2 EA																																																												
P-4		Right Large Top Support	1 EA	P-13		Monitor Rail	1 EA																																																												
P-5		Left Large Top Support	1 EA	<div style="border: 2px solid black; border-radius: 15px; padding: 10px; text-align: center;"> <h3>Hardware List</h3> <table border="0"> <tr> <td>A</td> <td></td> <td>9/16" Socket Screw</td> <td>20 EA</td> </tr> <tr> <td>B</td> <td></td> <td>1-7/8" Socket Screw</td> <td>4 EA</td> </tr> <tr> <td>C</td> <td></td> <td>2-3/8" Socket Screw</td> <td>8 EA</td> </tr> <tr> <td>D</td> <td></td> <td>Flat Washer</td> <td>4 EA</td> </tr> <tr> <td>E</td> <td></td> <td>Black Plastic Spacer</td> <td>2 EA</td> </tr> <tr> <td>F</td> <td></td> <td>Hex Nut</td> <td>4 EA</td> </tr> <tr> <td>G</td> <td></td> <td>Square Nut</td> <td>8 EA</td> </tr> <tr> <td>H</td> <td></td> <td>2" Locking Caster (for front)</td> <td>2 EA</td> </tr> <tr> <td>J</td> <td></td> <td>2" Caster (for Back)</td> <td>2 EA</td> </tr> <tr> <td>K</td> <td></td> <td>Allen Wrench</td> <td>1 EA</td> </tr> <tr> <td>L</td> <td></td> <td>Caster Wrench</td> <td>1 EA</td> </tr> </table> </div> <tr> <td>P-6</td> <td></td> <td>Large Top Platform</td> <td>1 EA</td> </tr> <tr> <td>P-7</td> <td></td> <td>Stability Panel</td> <td>2 EA</td> </tr> <tr> <td>P-8</td> <td></td> <td>Left Leg Receiver</td> <td>1 EA</td> </tr> <tr> <td>P-9</td> <td></td> <td>Right Leg Receiver</td> <td>1 EA</td> </tr>				A		9/16" Socket Screw	20 EA	B		1-7/8" Socket Screw	4 EA	C		2-3/8" Socket Screw	8 EA	D		Flat Washer	4 EA	E		Black Plastic Spacer	2 EA	F		Hex Nut	4 EA	G		Square Nut	8 EA	H		2" Locking Caster (for front)	2 EA	J		2" Caster (for Back)	2 EA	K		Allen Wrench	1 EA	L		Caster Wrench	1 EA	P-6		Large Top Platform	1 EA	P-7		Stability Panel	2 EA	P-8		Left Leg Receiver	1 EA	P-9		Right Leg Receiver	1 EA
A		9/16" Socket Screw	20 EA																																																																
B		1-7/8" Socket Screw	4 EA																																																																
C		2-3/8" Socket Screw	8 EA																																																																
D		Flat Washer	4 EA																																																																
E		Black Plastic Spacer	2 EA																																																																
F		Hex Nut	4 EA																																																																
G		Square Nut	8 EA																																																																
H		2" Locking Caster (for front)	2 EA																																																																
J		2" Caster (for Back)	2 EA																																																																
K		Allen Wrench	1 EA																																																																
L		Caster Wrench	1 EA																																																																
P-6		Large Top Platform	1 EA																																																																
P-7		Stability Panel	2 EA																																																																
P-8		Left Leg Receiver	1 EA																																																																
P-9		Right Leg Receiver	1 EA																																																																

Do not use unless all screws are tight. At least every six months, check all screws to be sure they are tight. If parts are missing, broken, damaged, or worn, stop use of the product until repairs are made by your dealer using factory authorized parts.

Should you require assistance during assembly, please call our Customer Service Department Monday - Friday 8 a.m. - 5 p.m. Central Standard Time

**Toll-Free Customer Service
1-800-749-2258**

FREEDOM Assembly Diagram



We recommend that you assemble this unit on a table.

Tools required: Adjustable Crescent Wrench

1. Identify and Separate all the Parts and Hardware.
2. Place the Small Top Platform (P-1) with the insert nuts facing up. Attach Right Small Top Support (P-2) and Left Small Top Support (P-3) using 4 each (C) screws. **(Finger tighten only)**
3. Attach Stability Panel (P-7) to Left & Right Small Top Supports (P-3& P-2) using 4 (A) Screws as shown in illustration #2.
(Tighten all the screws at this time)
4. Place the Large Top Platform (P-6) with the insert nuts facing up. Attach Right Large Top Support (P-4) and Left Large Top Support (P-5) using 4 each (C) screws. **(Finger tighten only)**
5. Attach Stability Panel (P-7) to Left & Right Large Top Supports (P-5 & P-4) using 4 (A) Screws as shown in illustration #2.
(Tighten all the screws at this time)
6. Attach Monitor Security Rail (P-13) to the Large Top Platform (P-6), using 4 (A) screws. **(Finger tighten only)**

Illustration #1

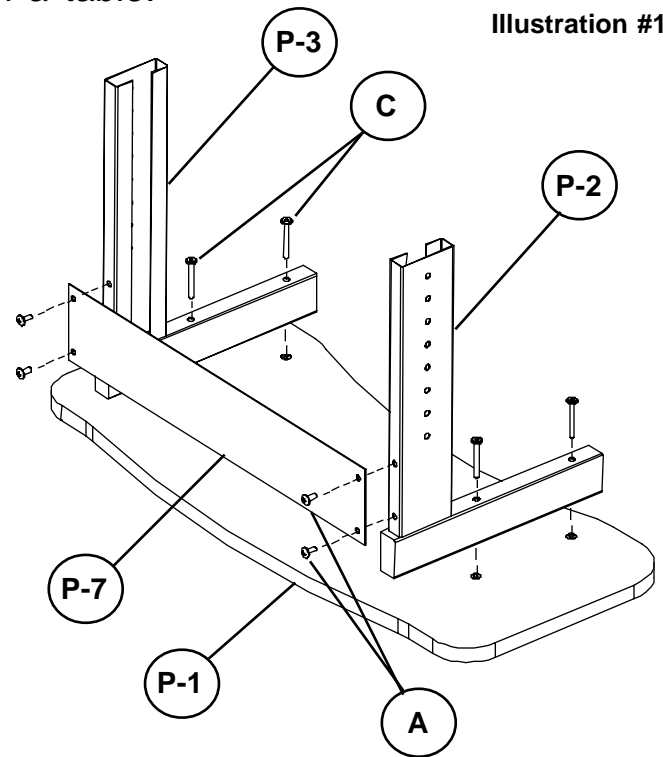
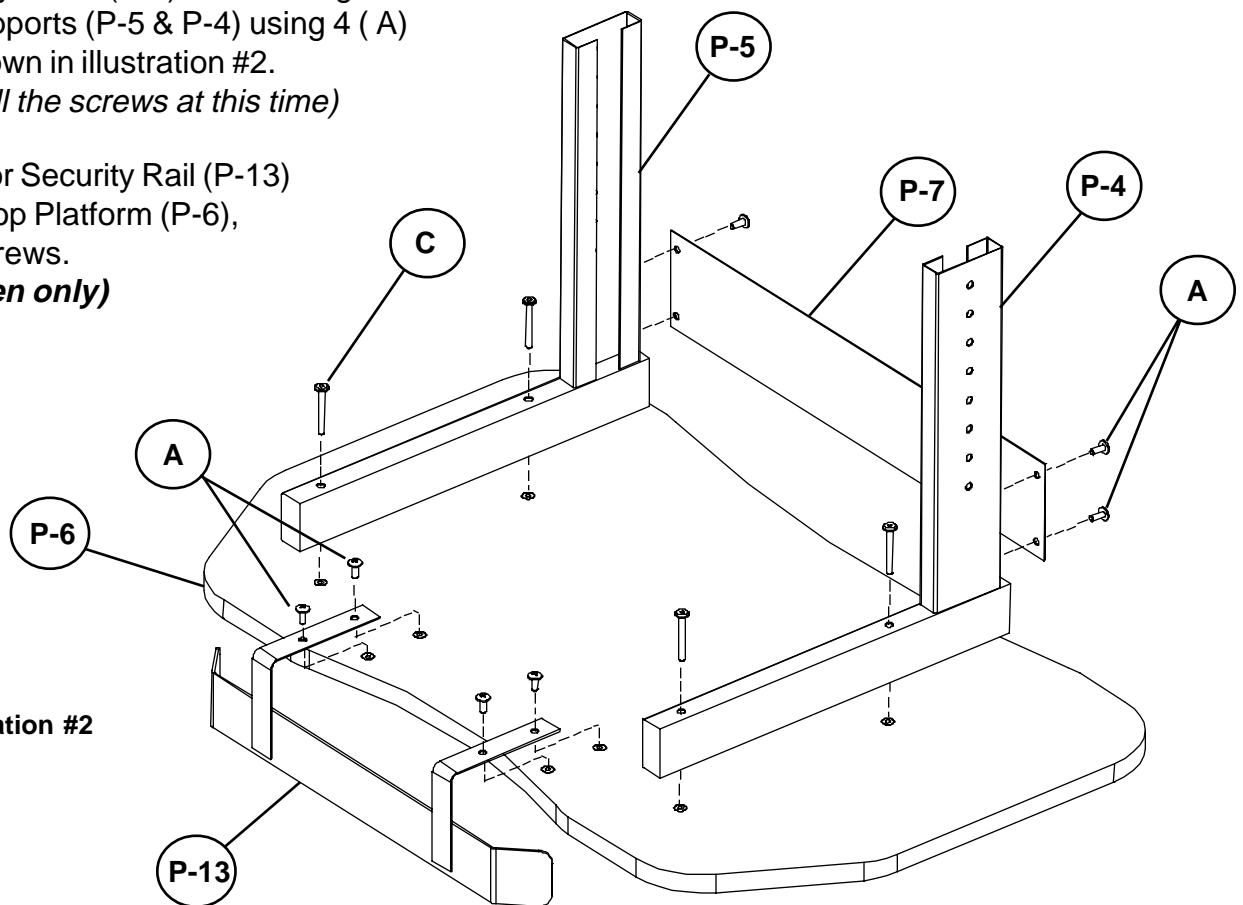

Illustration #2



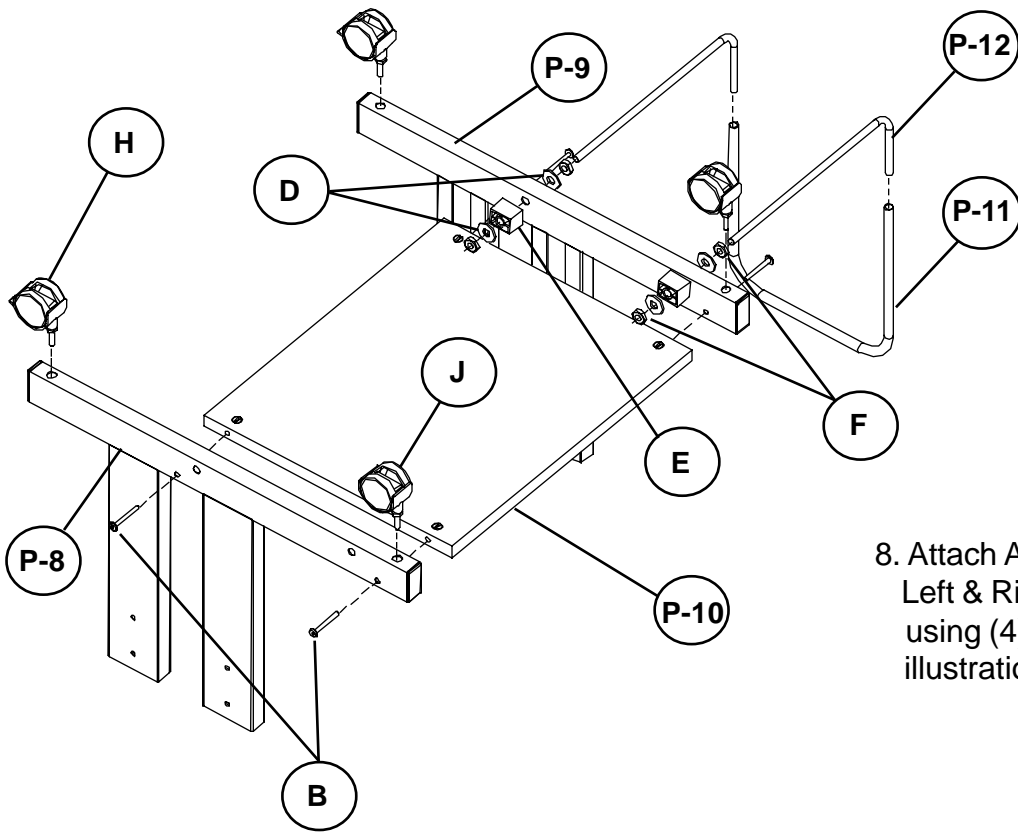

Illustration #3

8. Attach Accessory Platform (P-10) to Left & Right Leg Receivers (P-8 & P-9) using (4) B screws as shown in illustration #3.

9. Attach (2) each H Locking Casters to the front of the 2 each Leg receivers and (2) each J Casters to the back of the Leg Receivers.

10. Attach (2) each CPU Rods (P-12) to the Right Leg Receiver (P-9) or Left Leg Receiver (P-8) as shown in illustration #3. Secure each rod with (2) each F Hex nuts, (2) each D Flat Washers and (1) each E Black spacer. Slide CPU Sleeve (P-11) over ends of CPU Rods as shown in illustration #3.

Illustration # 4

11. Slide the assembled Small Platform and the Assembled Large Platform into the Assembled Lower Receiver and secure at the desired height with (8) each A Screws and (8) each G Square nuts (flat side of the nut should be next to the metal)

12. Tighten all screws securely.

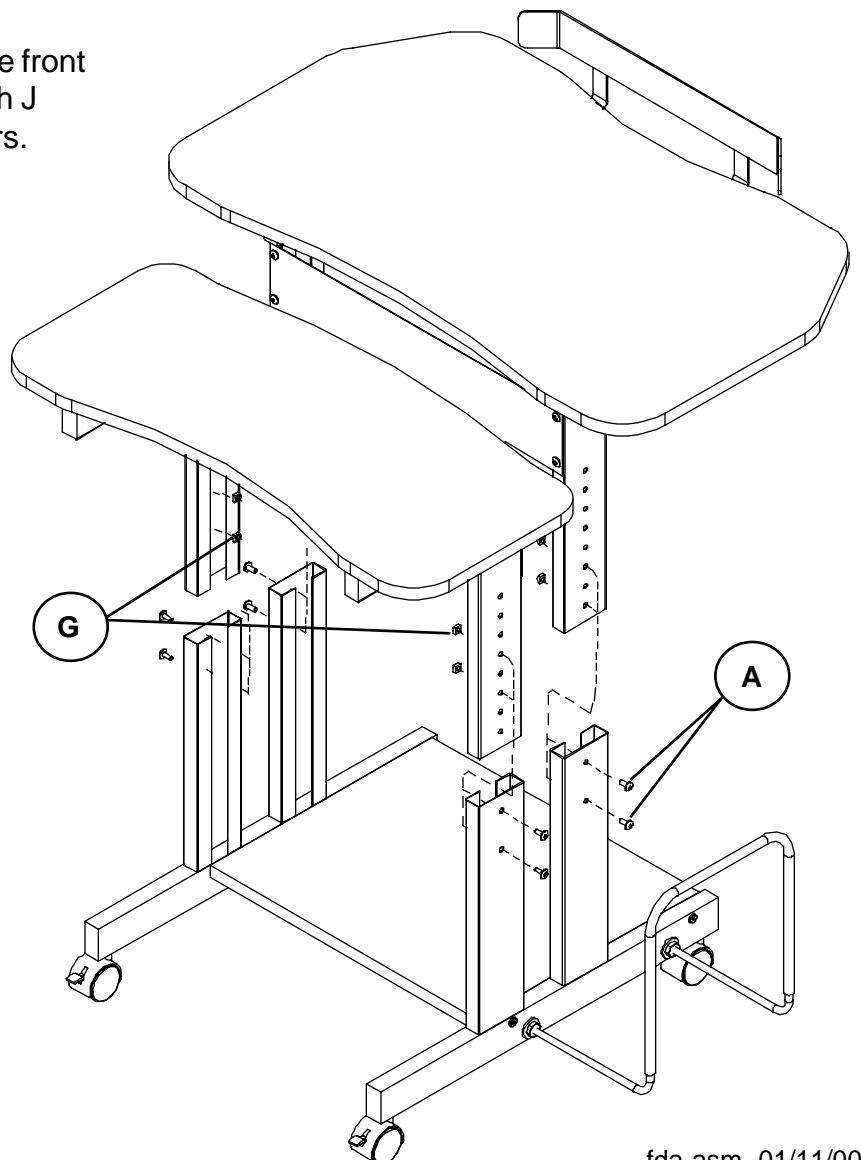

Illustration #4